



Set flow rates

Control components for VAV terminal units

Easy



VAV terminal unit type TVR with an Easy controller



VAV terminal unit type TVE with an Easy controller



Easy controller for TVE-Q series



For easy adjustment

Control components for VAV terminal units, to be mounted on the terminal unit for easy operation

- Simplified ordering and on-site assignment to rooms as selection is based on the nominal size of the duct
- Simple volume flow rate setting without additional device
- Indicator light simplifies functional checking
- With push button for triggering a function test
- Proven technology of the Compact volume flow controllers
- Suitable for constant and variable volume flow rates and q_{vmin} - q_{vmax} -Switching

General information	2	Variants	7
Function	3	Technical data	9
Specification text	5	Product details	17
Order code	6	Nomenclature	25

General information

Application

- All-in-one control devices for VAV terminal units
- Dynamic effective pressure transducer, electronic controller and actuator are fitted together in one casing
- Dynamic differential pressure transducer for clean air in ventilation and air-conditioning systems
- Standard filtration in comfort air-conditioning systems allows the controller to be used in the supply air without additional dust protection measures
- Various control options based on setpoint value default setting
- Volume flow rate control is based on setpoint values received from room temperature controller, central BMS, air quality controller or other devices as an analogue signal.
- Override control for activating q_{vmin} , q_{vmax} , shut-off or OPEN position can be set with a switch or relay
- The volume flow rate actual value is available as a linear voltage signal

If air is contaminated with dust, lint, sticky, moist or slightly aggressive particles:

- Do not use an Easy controller

Construction

- LMV-D3AL-F TR for LVC
- TR0VE-024T-05I-DD15 for TVE, TVE-Q
- LMV-D3A-F TR for TVR
- LMV-D3A TR for TZ-Silenzio, TA-Silenzio, TVZ, TVA
- 227V-024T-05-002 for TVR
- 227V-024T-05-002/RE20 for TZ-Silenzio, TA-Silenzio, TVZ, TVA
- 227V-024T-15-002 for TVJ, TVT up to and including 1000 × 500
- SMV-D3A TR for TVT from 1000 × 600

Parts and characteristics

- Transmitter based on dynamic measuring principle, can only be used with clean air, as a partial volume flow is passed through the transducer
- Mechanical stops for limiting the damper positions (not for TVE and TVE-Q)
- Actuators with overload protection
- Transparent protective cap or terminal cover (for TVE and TVE-Q)

Interface

- Analogue signal 0 – 10 V DC

Control strategy

- The volume flow controller works independent of the duct pressure
- Differential pressure fluctuations do not result in permanent volume flow rate changes
- To prevent the control from becoming unstable, a dead band is allowed within which the damper blade does not move
- Volume flow parameters can be easily changed by the customer

Operating modes

- Operating mode variable volume flow rate, q_{vmin} : minimum volume flow rate, q_{vmax} : maximum volume flow rate
- Operating mode Constant value, q_{vmin} : Constant volume flow rate, q_{vmax} : 100 %

Commissioning

- Operating values q_{vmin} , q_{vmax} to be set on site with potentiometer on the outside of the housing without additional adjustment tools

Function

Air terminal units control the volume flow in a closed loop, which means: measurement – comparison – adjustment.
The volume flow rate is obtained by measuring a differential pressure. This is done with a differential pressure sensor. The integrated differential pressure transducer converts the differential pressure into a voltage signal. The actual volume flow rate is available as a voltage signal. The factory setting is such that 10 V DC always corresponds to the nominal flow rate (q_{vNom}). The volume flow setpoint is specified by a higher-level controller (e.g. room temperature controller, air quality controller, building

management system) or by switching contacts. Variable volume flow control can be set between q_{vmin} and q_{vmax} . It is possible to override the room temperature control by forced switching, e.g. for a shut-off.
The controller compares the volume flow setpoint with the current actual value and adjusts the internal actuator according to the control deviation.
Volume flow parameter q_{vmin} and q_{vmax} can be set on potentiometers.

Principle of operation – LVC, TVR, TZ-Silenzio, TA-Silenzio, TVZ, TVA, TVJ, TVT

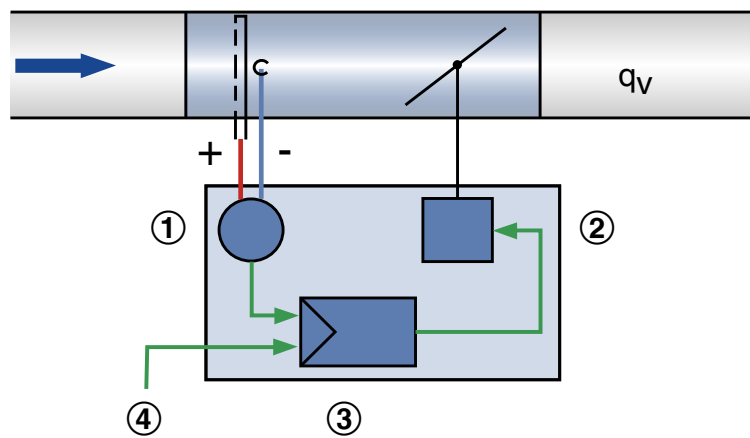

- ① Effective pressure transducer
- ② Actuator
- ③ Volume flow controller
- ④ Setpoint value signal

Functional principle of the TVE and TVE-Q control unit series

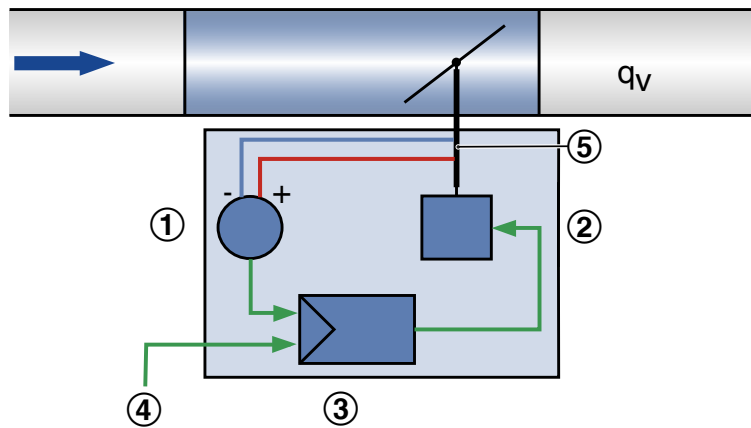

- ① Differential pressure transducer
- ② Actuator
- ③ Volume flow controller
- ④ Setpoint value signal
- ⑤ Shaft with effective pressure channel

Specification text

This specification text describes the general properties of the product.

Category

Easy controller for volume flow with potentiometer setting for

q_{vmin} , q_{vmax}

Application

- Control of a constant or variable volume flow rate setpoint
- Electronic controller for applying a reference value and capturing an actual value signal
- The actual value signal relates to the nominal volume flow rate so that commissioning and subsequent adjustment are simplified
- Stand-alone operation or integration with a central BMS

Area of application

- Dynamic transducer for clean air in ventilation and air conditioning systems

Actuator

- Integral; slow running (run time 100–270 s for 90°)

Installation orientation

- Either direction

Connection

- Double terminal for supply voltage to connect up to 3 controllers
- No terminal box required.

Supply voltage

- 24 V AC/DC

Interface/signalling

- Analogue signal 0 – 10 V DC

Interface information

- Volume flow setpoint; actual volume flow rate
- The actual value signal relates to the nominal volume flow rate so that commissioning and subsequent adjustment are simplified

Special functions

- Clearly visible external indicator light for signalling the functions: Set, not set, and power failure
- Activation of V_{min} , V_{max} , closed, open by external switch contacts/circuitry

Parameter setting

- Specific parameters for VAV terminal unit are factory-set
- Operating values q_{vmin} , q_{vmax} to be set on site with potentiometer on the outside of the housing without additional adjustment tools

Factory condition

- Electronic controller is factory mounted on the control unit
- Factory-set parameters
- Functional test with air (see sticker)



Order code

Control component Easy (shown together with TVR as an example)

TVR – D / 200 / D2 / Easy

| | | | |
1 2 5 6 7

1 Type

TVR VAV terminal unit

2 Acoustic cladding

No entry: none

D With acoustic cladding

5 Nominal size [mm]

100, 125, 160, 200, 250, 315, 400

Order example: TVR-D/200/D2/Easy

Type	TVR
Acoustic cladding	With acoustic cladding
Nominal size [mm]	200
Accessories	Double lip seal both ends
Attachments (control component)	Easy controller

6 Accessories

No entry: without accessories

D2 Lip seals on both ends

G2 Matching flanges for both ends

7 Attachments (control component)

Easy Easy controller

Variants

Easy controller type 1 (only TVE, TVE-Q)



Easy controller type 1 (only TVE, TVE-Q)



- 1: Easy controller
- 2: Release button and damper blade position indicator
- 3: q_{vmin} -Potentiometer
- 4: q_{vmax} -Potentiometer
- 5: Push-button for the test function with LED for displaying the operating states
- 6: Terminals

- 1: Terminal cover (part of the supply package)

Easy controller type 2 with positive lock



- 1: Connections for pressure transducer
- 2: Easy controller
- 3: Axle connection with positive locking
- 4: LED for indicating operating states
- 5: Button for test function
- 6: Terminals

Easy controller type 2 with clamping device



- 1: q_{vmin} -Potentiometer
- 2: q_{vmax} -Potentiometer
- 3: Axle connection with clamping device

Easy controller type 3 with positive lock

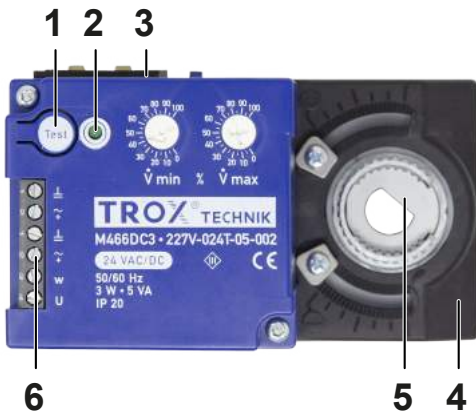

- 1: Push-button for the test function with LED for displaying the operating states
- 2: LED for indicating operating states
- 3: Connections for pressure transducer
- 4: Easy controller
- 5: Axle connection with positive locking
- 6: Terminals

Easy controller type 3 with clamping device



- 1: q_{vmin} -Potentiometer
- 2: q_{vmax} -Potentiometer
- 3: Axle connection with clamping device

Technical data

Easy controllers for VAV terminal units

Part number	Type	VAV terminal units
M466EU1	LMV-D3AL-F TR	LVC
A00000069228	TR0VE-024T-05I-DD15	TVE, TVE-Q
M466ES1	LMV-D3A-F TR	TVR
M466DC3	227V-024T-05-002	TVR
M466ES2	LMV-D3A TR	TZ-Silenzio, TA-Silenzio, TVZ, TVA
A00000089738	227V-024T-05-002/RE20	TZ-Silenzio, TA-Silenzio, TVZ, TVA
A00000053055	227V-024T-15-002	TVJ and TVT up to 1000 × 500
M466ES3	SMV-D3A TR	TVT from 1000 × 600

Easy controller LMV-D3LA-F



Easy controller LMV-D3AL-F TR for VAV terminal unit LVC

Type of measurement/installation orientation	Dynamic measurements, any installation orientation
Supply voltage (AC)	24 V AC \pm 20%, 50/60 Hz
Supply voltage (DC)	24 V DC -10/+20 %
Power rating (AC)	3.5 VA max.
Power rating (DC)	2 W max.
Run time for 90°	120 – 150 s
Setpoint value signal input	0 – 10 V DC, $R_a > 100 \text{ k}\Omega$
Actual value signal output	0 – 10 V DC, 0.5 mA max.
IEC protection class	III (protective extra-low voltage)
Protection level	IP 20
EC conformity	EMC to 2014/30/EU, low voltage to 2014/35/EU

Easy controller TR0VE-024T-05I-DD15 for VAV terminal unit TVE



Easy controller TR0VE-024T-05I-DD15 for VAV terminal unit TVE

Type of measurement/installation orientation	Dynamic measurements, any installation orientation
Supply voltage (AC)	24 V AC \pm 20%, 50/60 Hz
Supply voltage (DC)	24 V DC \pm 20 %
Power rating (AC)	TVE NW 100 - 160: maximum 4 VA TVE NW 200 - 400: maximum 7 VA TVE-Q up to height 200: maximum 4 VA TVE-Q from height 300: maximum 7 VA
Power rating (DC)	TVE NW 100 - 160: maximum 2.5 W TVE NW 200 - 400: maximum 4 W TVE-Q up to height 200: maximum 2.5 W TVE-Q from height 300: maximum 4 W
Power consumption (when running/when idle)	1 W
Run time for 90°	100 s
Setpoint value signal input	0 – 10 V DC, $R_a > 100 \text{ k}\Omega$
Actual value signal output	0 – 10 V DC, 0.5 mA max.
IEC protection class	III (protective extra-low voltage)
Protection level	IP 42 (with the terminal cover attached)
EC conformity	EMC to 2014/30/EU

Easy controller LMV-D3A TR for VAV terminal units TZ-Silenzio, TA-Silenzio, TVZ and TVA

Easy controller LMV-D3A-F TR for VAV terminal unit TVR



**Easy controller LMV-D3A
For VAV control units TVR, TZ-Silenzio, TA-Silenzio, TVZ, TVA**

Type of measurement/installation orientation	Dynamic measurements, any installation orientation
Supply voltage (AC)	24 V AC \pm 20 %, 50/60 Hz
Supply voltage (DC)	24 V DC -10/+20 %
Power rating (AC)	5 VA max.
Power rating (DC)	2.5 W max.
Run time for 90°	110 – 150 s
Setpoint value signal input	0 – 10 V DC, $R_a > 100 \text{ k}\Omega$
Actual value signal output	0 – 10 V DC, 0.5 mA max.
IEC protection class	III (protective extra-low voltage)
Protection level	IP 20
EC conformity	EMC to 2014/30/EU

Easy controller 227V-024T-05-002/RE20 for VAV terminal units TZ-Silenzio, TA-Silenzio, TVZ and TVA

Easy controller 227V-024T-05-002 for VAV terminal unit TVR



Easy controller 227V-024T-05-002(/RE20) for VAV terminal units TVR, TZ-Silenzio, TA-Silenzio, TVZ and TVA

Type of measurement/installation orientation	Dynamic measurements, any installation orientation
Supply voltage (AC)	24 V AC \pm 20 %, 50/60 Hz
Supply voltage (DC)	24 V DC \pm 20 %
Power rating (AC)	5 VA max.
Power rating (DC)	3 W max.
Run time for 90°	100 s
Setpoint value signal input	0 – 10 V DC, Ra > 100 k Ω
Actual value signal output	0 – 10 V DC, 0.5 mA max.
IEC protection class	III (protective extra-low voltage)
Protection level	IP 20
EC conformity	EMC to 2014/30/EU

Easy controller 227V-024T-15-002 for VAV terminal units TVJ and TVT up to NW 1000 x 500



Easy controller 227V-024T-15-002 for VAV controllers TVJ, TVT up to and including NW 1000 x 500

Type of measurement/installation orientation	Dynamic measurements, any installation orientation
Supply voltage (AC)	24 V AC \pm 20%, 50/60 Hz
Supply voltage (DC)	24 V DC \pm 20 %
Power rating (AC)	5 VA max.
Power rating (DC)	3 W max.
Run time for 90°	150 – 270 s
Signal input setpoint value	0 – 10 V DC, Ra > 100 k Ω
Signal output actual value	0 – 10 V DC, max. 0,5 mA
IEC protection class	III (Protective extra-low voltage)
Protection level	IP 20
EC conformity	EMC to 2014/30/EU

Easy controller SMV-D3A TR for VAV terminal unit TVT from NW 1000 x 600



Easy controller SMV-D3A TR for VAV terminal unit TVT from NW 1000 x 600

Type of measurement/installation orientation	Dynamic measurements, any installation orientation
Supply voltage (AC)	24 V AC \pm 20 %, 50/60 Hz
Supply voltage (DC)	24 V DC -10/+20 %
Power rating (AC)	6 VA max.
Power rating (DC)	3 W max.
Run time for 90°	110 – 150 s
Setpoint value signal input	0 – 10 V DC, $R_a > 100 \text{ k}\Omega$
Actual value signal output	0 – 10 V DC, max. 0,5 mA
IEC protection class	III (protective extra-low voltage)
Protection level	IP 20
EC conformity	EMC to 2014/30/EU

Cut-out LED button

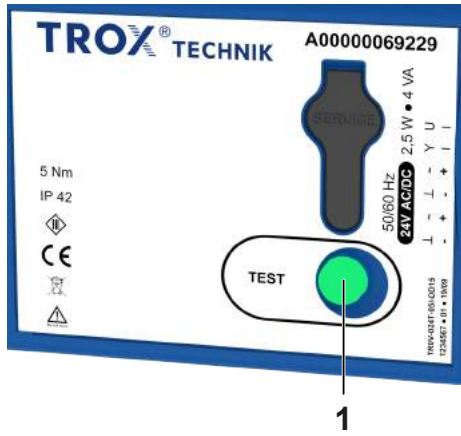

1: LED push button

Description of status LEDs and error messages

LED flashing signal	Status	Display
	no power supply connected	
	Service tool plugged in. On-site network connection deactivated. Forced controls from the service tool have priority	
	Undervoltage detected. Supply voltage outside the tolerance range. Control function not guaranteed	
	TROX service technicians provide information. Incomplete parameterisation was detected during power-on/reset *	
	Drive overload detected (block) *	
	Synchronisation drive after Power Up *	
	Test mode enabled *	
	Overpressure sensor (Overpressure) *	
	Setpoint or forced control position not yet reached (display changes between e.g. Hi = high and actual value) *	
	Forced control position reached (display changes between e.g. Hi = High and actual value) *	
	Offset: Is signalled as long as the drive does not rotate to readjust the setpoint value *	

Notes:

- The signal spans 2 seconds. 1 = LED is illuminated, 0 = LED is not illuminated
- For service tool plugged in (display: Pc) and undervoltage detected (display: Lou), no special flashing signal appears on the LED button. Instead, one of the operating states marked with an asterisk (*) is displayed.

Starting a test run for control components on VAV terminal units type TVE

Pressing the LED push button for > 2 s starts a test run.

Description of status LEDs and error messages regarding control components for terminal units LVC, TVR, TVJ, TVT, TZ-Silenzio, TA-Silenzio, TVZ and TVA

LED	Operating status
OFF	<ul style="list-style-type: none">No powerEasy controller defect
ON	Flow rate setpoint value has been reached
Blinking slowly (0.5 Hz)	<ul style="list-style-type: none">Actual value \neq setpoint valueController is trying to achieve the setpoint or <ul style="list-style-type: none">Test in progressSynchronisation in progress
Blinking rapidly (2.5 Hz)	Direction of rotation has been changed

Product details

Analogue interface (0-10 V DC)

With the Easy controller, the analogue interface for the signal voltage range is set to 0 - 10 V DC. The assignment of volume flow setpoint or actual value to voltage signals is shown in the characteristic diagrams. The signal voltage range applies equally to setpoint and actual value signals.

Setpoint value setting

For a variable air volume control range (e.g. control by temperature controller or air quality controller) the Setpoint input with an analogue signal at terminal Y or w.

The signal voltage range 0 - 10 V DC is matched to the flow rate range set on the control component $q_{vmin} - q_{vmax}$ a change packet. No separate setting device is required to set the working range. The setting is made on-site at potentiometers directly on the control component and can also be easily adjusted at a later date.

Set are q_{vmin} and q_{vmax} as a percentage value of the nominal volumetric flow of the control unit. Setting values can also be read from the scale sticker located on the controller.

For fixed-value operation (constant volumetric flow), no analogue signal is required at the Y or w terminal.

The value determined by the q_{vmin} . The fixed volume flow rate value set with the potentiometer is controlled.

Actual value as feedback for monitoring or tracking control

The actual volume flow rate measured by the controller can be captured as a voltage signal at terminal U

The signal voltage range 0 - 10 V DC is set to the volume flow range 0 - q_{vnom} of the air terminal unit.

Override control

For specific operating situations, the volume flow controller can be set to a special operating mode (override control).

Possible modes: Control q_{vmin} , control q_{vmax} , control damper in open position (OPEN) or control damper closed (CLOSED).

Override control by wiring at signal input Y or w

With suitable wiring at signal input Y, the override controls can be controlled according to the connection diagrams by means of The unit can be activated by means of external switching contacts/relays. OPEN and CLOSED are only available when the controller is supplied with

Alternating voltage (AC) is available.

The override control can thus also be used to implement a simple 2-point control with switching between two operating values, e.g. for day and night operation with different fixed volumetric flow values.

Override control CLOSED by command signal Y or w

The override control CLOSE can also be activated under certain conditions via the command signal Y or w (setpoint).

Prerequisite:

Potentiometer $q_{vmin} = 0$ and the setpoint signal falls below the shut-off level.

If the setpoint signal falls below the shut-off level, the control damper is moved to the shut-off position

Shut-off level:

Easy controller for control unit series TVE and TVE-Q:

Shut-off level = 0.3 V DC

Easy controller for all other controller series:

Shut-off level = 0.5 V DC

Note:

In practice, falling below the shut-off level of 0.3 V DC or 0.5 V DC cannot always be realised safely, depending on the project environment. Therefore, for the shut-off function, override control by means of wiring at signal input Y or w is recommended.

Commissioning

- Take the adjustment values from the volume flow rate scale (sticker on each VAV terminal unit)
- Use the potentiometer to set the minimum or maximum volume flow rate on site
- Comply with the volume flow rate control range, do not set a volume flow rate which is below the minimum flow rate
- Volume flow rate control range TVE: 4 – 100%
- Volume flow rate control range TVE: 10 – 100%
- Volume flow rate control range of LVC, TVR, TZ-Silenzio, TA-Silenzio, TVZ and TVA: 10 – 100%
- Volume flow rate range of TVJ and TVT: 20 – 100%
- Once the VAV terminal unit has been installed and wired, and the volume flow rate has been set, the unit is ready for operation
- Remove the transparent protective cover or terminal cover (for TVE or TVE-Q variants) of the Easy controller only briefly for wiring or commissioning

Select nominal size

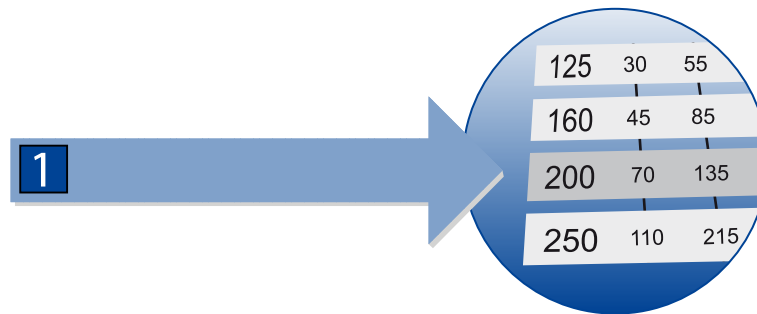

Set flow rates

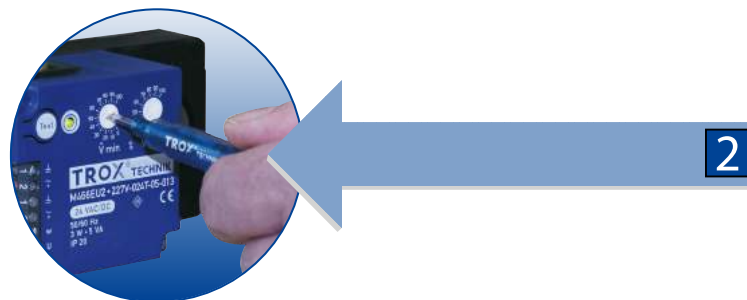

Green light: Ready!

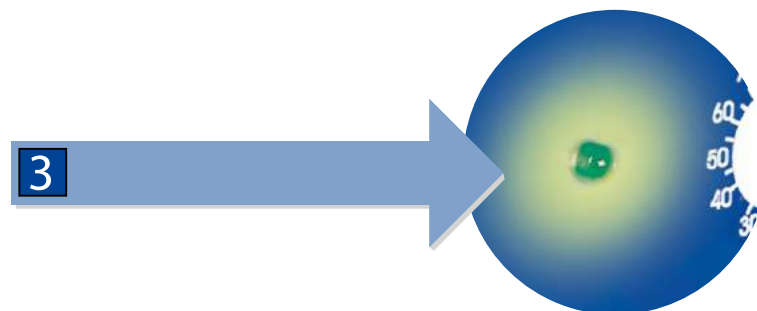

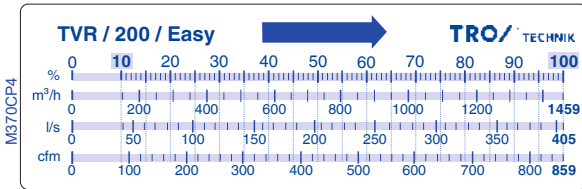

Variable volume flow control

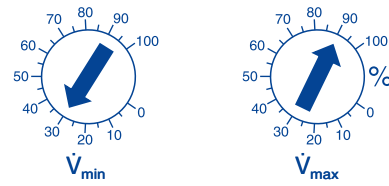

Each VAV terminal unit with Easy controller carries a sticker with a volume flow rate scale to determine the setting values at the customer's site (see example: TVR Easy, nominal size 200). The percentages refer to the control range that can be used. Numbers on the right-hand label edge document the 100 % value, i.e. the size-dependent nominal volume flow q_{vnom} of the respective control unit.

The required volume flow rates must be set on site (by others).

- If q_{vmin} is set higher than q_{vmax} , q_{vmin} is provided as a constant volume flow rate even if a setpoint value signal is transmitted.
- If q_{vmin} is set to 0%, then control is between shut-off and q_{vmax} held
- If the setpoint signal falls below the shut-off level, the damper blade moves to the shut-off position

Shut-off level

- Easy controller for controller series TVE and TVE-Q: Shut-off level = 0.3 V DC
- Easy controller for all other controller series: Shut-off level = 0.5 V DC

Constant volume flow control

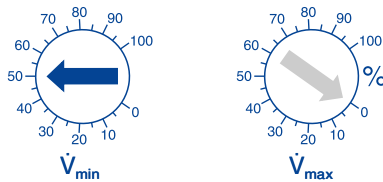

Control input signal from the central BMS

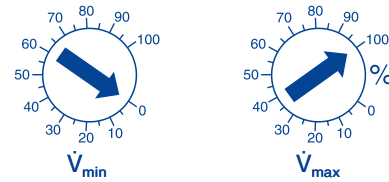

The constant volume flow rate is set using the q_{vmin} potentiometer. The setting of the q_{vmax} potentiometer is in this case irrelevant.

If the volume flow is to be specified by the BMS, the q_{vmin} -Potentiometer set to 0 % and the q_{vmax} potentiometer to 100%.

- If the setpoint signal falls below the shut-off level, the damper blade moves to the shut-off position
- In practice, falling below the shut-off level of 0.3 V DC or 0.5 V DC cannot always be realised safely. So shut-off by override control is recommended.

Factory setting

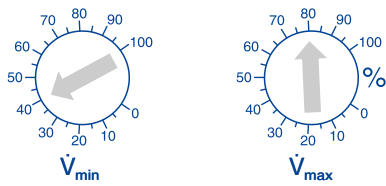

Units are factory set to $q_{vmin} = 40\%$ and $q_{vmax} = 80\%$ set. This sets a variable volume flow control in the operating range of 40 - 80 % of the respective nominal volume flow of the control unit.

Analogue interface 0 – 10 V or 2 – 10 V DC (operating mode V, F)

The analogue interface can be set for the signal voltage range 0 - 10 V or 2 - 10 V. The assignment of volume flow setpoint or actual value to voltage signals is shown in the characteristic diagrams.

- Set voltage range always applies equally to setpoint and actual value signals
- Signal voltage range preset at the factory according to the order key specifications
- Signal voltage range can be measured on site with a setting device

Characteristic of the setpoint value signal

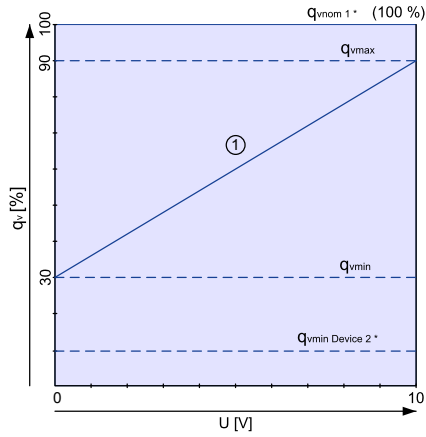

- ① Signal voltage range 0 – 10 V
- 1* = q_{vnom} Nominal volume flow rate (q_{vnom})
- 2* = $q_{vmin Device}$ Acceptable minimum volume flow ($q_{vminUnit}$)

Characteristic of the actual value signal

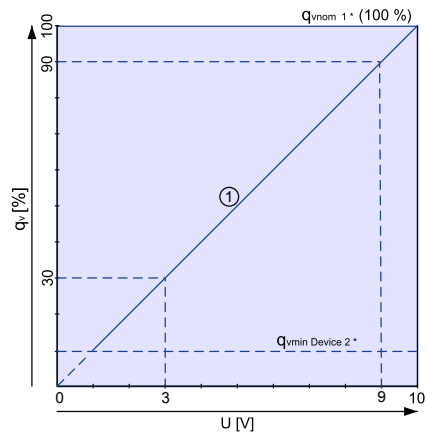

- ① Signal voltage range 0 – 10 V
- 1* = q_{vnom} Nominal volume flow rate (q_{vnom})
- 2* = $q_{vmin device}$ Acceptable minimum volume flow ($q_{vmin unit}$)

Calculation of volume flow rate setpoint value at 0 – 10 V

$$q_{vset} = \frac{Y}{10 V} \times (q_{vmax} - q_{vmin}) + q_{vmin}$$

Calculation of actual volume flow rate at 0 – 10 V

$$q_{vact} = \frac{U}{10 V} \times q_{vnom}$$

Terminal connections

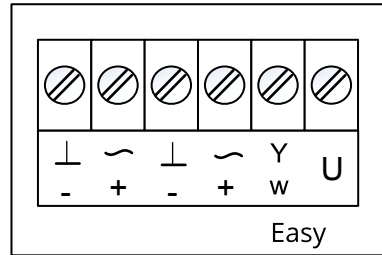

⊥, -: Ground

~, +: Supply voltage 24 V

Y, w: Setpoint value signal 0 – 10 V DC

U: Actual value signal 0 – 10 V DC

Signalling 0 – 10 V DC and override controls

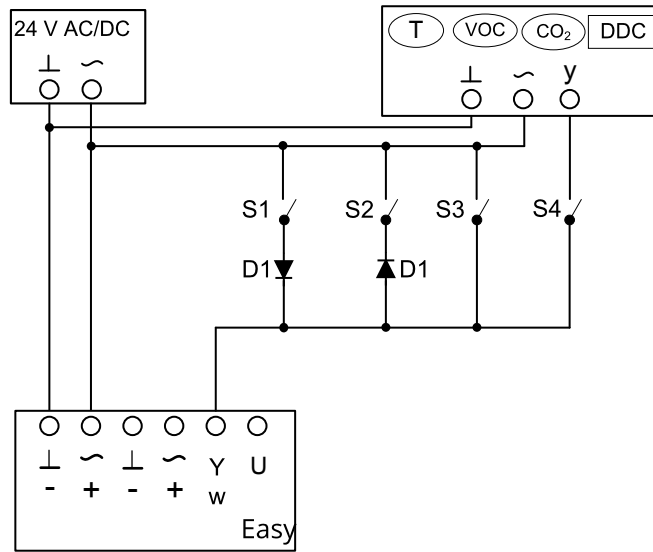

Nomenclature

- ⊥, - = Ground, neutral
- ~, + = Supply voltage 24 V AC/DC
- Y, w = Setpoint value signal and override control
- U = Actual value signal

Notes

- T, VOC, CO₂, DDC = Setpoint value default setting q_v
- D1 = Diode for override control, e.g. 1N4007
- When combining several override controls the switches must be interlocked to prevent short-circuits
- Setpoint and actual value signal always 0 - 10 V DC

Switch settings

Constant value mode q_{vmin} (Override control q_{vmin})

- All switches (connections) S1 - S4 must be open,
- No wiring is required except for the supply voltage

Regular operation $q_{vmin} - q_{vmax}$

- E.g. for room temperature control
- Only S4 has to be closed

Override control q_{vmax}

- Only S3 has to be closed

Override control, damper blade OPEN

- Only S1 has to be closed
- Only with AC voltage supply

Override control, damper blade CLOSED

- Only S2 has to be closed
- Only with AC voltage supply

Damper blade CLOSED with setpoint value signal

- Only S4 has to be closed
- Further boundary conditions: q_{vmin} -Setting = 0
- Control damper closed CLOSED is activated when command signal Y or w < shut-off level
- Easy controller shut-off level for TVE and TVE-Q controller series: 0.3 V DC
- Easy controller shut-off level for all other controller series: 0.5 V DC

Parallel connection of several Easy controllers

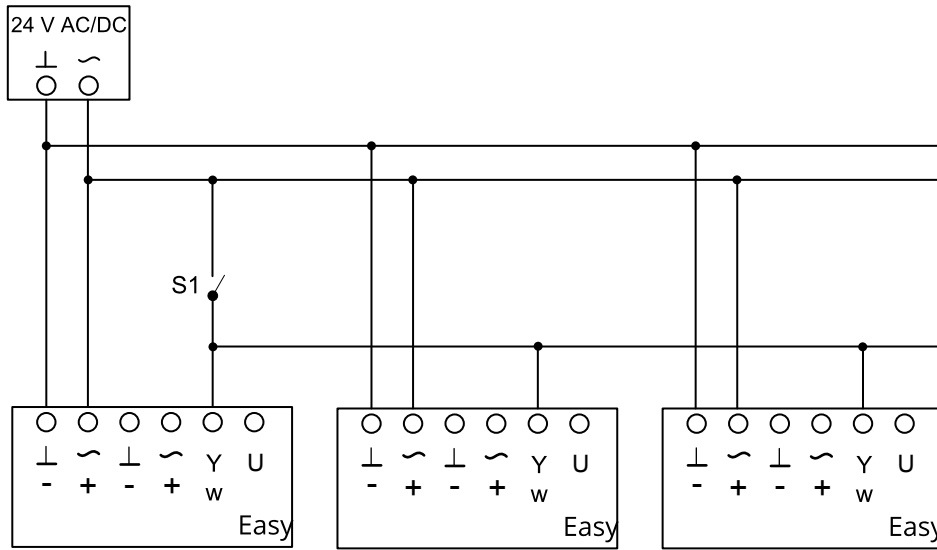

⊥, -: Ground

⊥, +: Supply voltage 24 V

Y, w: Setpoint value signal 0 – 10 V DC

U: Actual value signal 0 – 10 V DC

Switch functions:

S1 = Switch OPEN = minimum volume flow rate q_{vmin}

S1 = Switch CLOSED = maximum volume flow rate q_{vmax}

Nomenclature

q_{vNom} [m³/h]; [l/s]; [CFM]

Nominal flow rate (100 %): The value depends on product type, nominal size and control component (attachment). Values are published on the internet and in technical leaflets and defined in the Easy Product Finder design programme. Reference value for calculating percentages (e.g. q_{vmax}). Upper limit of the setting range and maximum volume flow rate setpoint value for the VAV terminal unit.

$q_{vmin Unit}$ [m³/h]; [l/s]; [CFM]

Technical minimum volume flow: The value depends on product type, nominal size and control component (attachment). Values are defined in the Easy Product Finder design programme Lower limit of the setting range and minimum volume flow rate setpoint value for the VAV terminal unit. Setpoint values below $q_{vmin Unit}$ (if q_{vmin} equals zero) may result in unstable control or shut-off.

q_{vmax} [m³/h]; [l/s]; [CFM]

Client-adjustable upper limit of the operating range for the VAV terminal unit: q_{vmax} can be set to less than or equal to q_{vNom} on the terminal unit. In case of analogue control of volume flow controllers (typically used), the maximum value of the setpoint signal (10 V) is assigned to the set maximum value (q_{vmax} , see characteristics).

q_{vmin} [m³/h]; [l/s]; [CFM]

Client-adjustable lower limit of the operating range of the VAV terminal unit: q_{vmin} should be set to less than or equal to q_{vmax} . q_{vmin} must not be set to less than $q_{vmin Unit}$, as the control may become unstable or the damper blade may close. q_{vmin} may equal zero. In case of analogue control of volume flow controllers (typically

used), the minimum value of the setpoint signal (0 or 2 V) is assigned to the set minimum value (q_{vmin} , see characteristics).

q_v [m³/h]; [l/s]; [CFM]

Volume flow rate

Volume flow controller

Consists of a basic unit with an attached control component.

Basic unit

Unit for controlling volume flow rates without an attached control component. The main components include the casing with sensor(s) to measure the differential pressure and the damper blade to restrict the volume flow. The basic unit is also referred to as a VAV terminal unit. Important distinguishing features: Geometry or unit shape, material and connection variants, acoustic characteristics (e.g. optional acoustic cladding or integrated silencers), range of volume flow.

Control component

Electronic unit(s) mounted on the basic unit to control the volume flow rate, or the duct pressure, or the room pressure by adjusting the damper blade position. The electronic unit mainly consists of a controller with differential pressure transducer (integrated or external), and an integrated actuator (Easy and Compact controllers) or external actuator (Universal or LABCONTROL controller). Important distinguishing features: Transducer: dynamic transducer for clean air, or static transducer for polluted air. Actuator: Standard actuator (slow-running), spring return actuator for fail-safe position, or fast-running actuator. Interface technology: analogue interface or digital bus interface for connecting and recording signals and data.