

Adjustable air control blades



4 fixing options



3 connection variants for water

Active chilled beams

DID-F

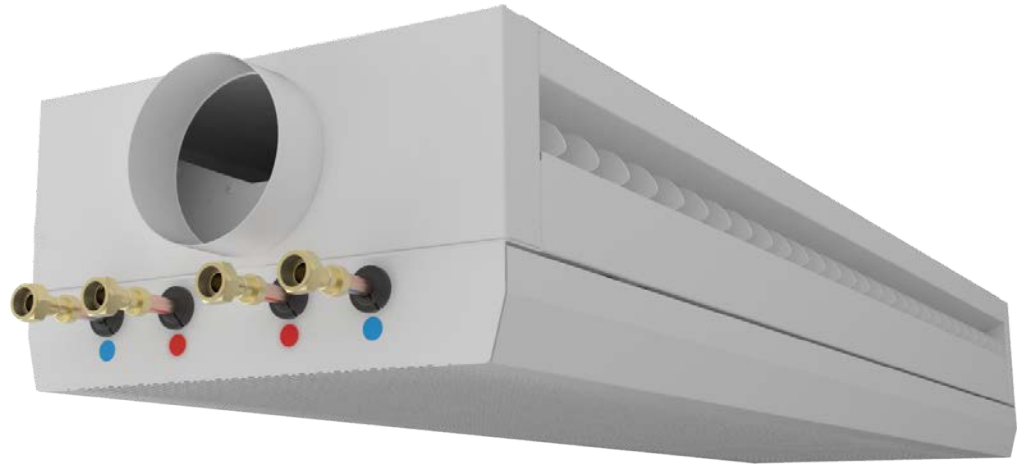

Compact active chilled beam with two-way air discharge, can be easily combined with other systems for room temperature control, such as concrete core activation

Active chilled beam for freely suspended installation, no suspended ceiling required

- Inexpensive solution for refurbishments and spaces of low floor-to-ceiling height
- Compact ventilation system for room temperature control with open ceiling design
- Flexible application – installation directly below the ceiling slab or freely suspended in the room
- Ducts and water pipes in the room can be short since connections on the narrow side of the beam allow for air and water being provided from the corridor side
- Manually adjustable air pattern with optionally available air control blades
- Reduced height thanks to horizontal heat exchanger and high thermal load dissipation with water

General information	2	Order code	9
Function	3	Variants	10
Technical data	5	Dimensions	14
Quick sizing	5	Project-specific solutions	17
Specification text	8	Nomenclature	19

General information

Application

- Active chilled beams for direct installation below the ceiling slab or freely suspended in the room
- A suspended ceiling is not required, which means that these devices can ideally be combined with concrete core activation
- Preferably for installation up to 4 m high, even if the room is higher
- Heating with the DID-F is only possible if the device is installed directly below the ceiling slab and the installation height is ≤ 4 m
- Adjustable air control blades allow for later manual adjustment of the air discharge direction
- Preferably with a 2-pipe heat exchanger for cooling; with direct installation below the ceiling slab, a 4-pipe heat exchanger for cooling and heating is an option
- Good comfort levels with a low conditioned primary air volume flow rate
- Energy-efficient solution as water is used for heating and cooling

Special features

- The optional duct covering allows for installation of the active chilled beam in the middle of the ceiling even if a room is large, as the same covering is used for ducts and water pipes to create a uniform look
- Manually adjustable air control blades for air direction control enable reduction of v_{h1} and v_l velocities in the occupied zone
- Horizontal heat exchanger as a 2-pipe system and, for direct installation below the ceiling and a maximum installation height of 4 m, also as a 4-pipe system for heating and cooling
- Internal nozzle plate with non-combustible punched nozzles
- Water connections at the narrow side, $\varnothing 12$ mm Cu pipe with plain tails, with $G\frac{1}{2}$ " external thread and flat seal, or with $G\frac{1}{2}$ " union nut and flat seal

Nominal sizes

- 1200, 1500, 1800, 2100, 2400, 2700, 3000 mm

Variants

Heat exchanger

- 2: For 2-pipe systems
- 4: For 4-pipe systems

Nozzle variants

- HE: Small
- S1: Medium
- S2: Large
- HP: Extra large

Attachments

Water connections

- No entry required: $\varnothing 12$ mm pipe with plain tails
- A1: with $G\frac{1}{2}$ " external thread and flat seal
- A2: with $G\frac{1}{2}$ " union nut and flat seal

Air control blades for subsequent manual adjustment of the supply air flow.

Accessories

- Covering for ducts and water pipes, if the active chilled beam is installed in the centre of the room (duct covering has the same shape as the DID-F)
- Heating and cooling valves for controlling the cooling and heating capacity

Useful additions

- Connecting hoses
- Control equipment consisting of a control panel including a controller with integral room temperature sensor; valves and valve actuators; and lockshields
- X-AIRCONTROL control system with the option of integration with the central BMS

Construction features

- Duct connection suitable for circular ducts in accordance with EN1506 or EN13180
- Various fixing systems for suspension with hooks, ropes, threaded rods or installation directly below the ceiling slab
- 4 nozzle variants for demand-based induction
- Induced air grille with circular holes, staggered pitch
- Air and water connections at the narrow side

Materials and surfaces

- Casing, induced air grille, spigot, brackets and duct covering made of galvanised sheet steel
- Nozzle plate made of sheet steel
- Heat exchanger with copper tubes and aluminium fins
- Exposed surfaces are powder-coated pure white (RAL 9010) or in any other RAL CLASSIC colour
- Air control blades made of polypropylene, UL 94, flame retardant (V0)

Standards and guidelines

- Products are certified by Eurovent (no. 09.12.432) and listed on the Eurovent website
- Declaration of hygiene conformity to VDI 6022

Maintenance

- No moving parts, hence low maintenance
- The heat exchanger can be vacuumed with an industrial vacuum cleaner if necessary
- VDI 6022, Part 1, applies (hygiene requirements for ventilation and air-conditioning systems and units)

Function

Active chilled beams provide centrally conditioned primary air (fresh air) to the room and use heat exchangers for additional cooling and/or heating. The primary air is discharged through nozzles (4 variants) into the mixing chamber; as a result of this, secondary air is induced. Secondary air (room air) is induced via the induced air grille and passes through the horizontal heat

exchanger, where it is heated or cooled. Primary and secondary air mix and are then supplied to the room through the supply air slots at the side. The DID-F fulfils this function without a suspended ceiling and can either be installed directly under the ceiling slab or suspended in the room.

Schematic illustration of DID-F

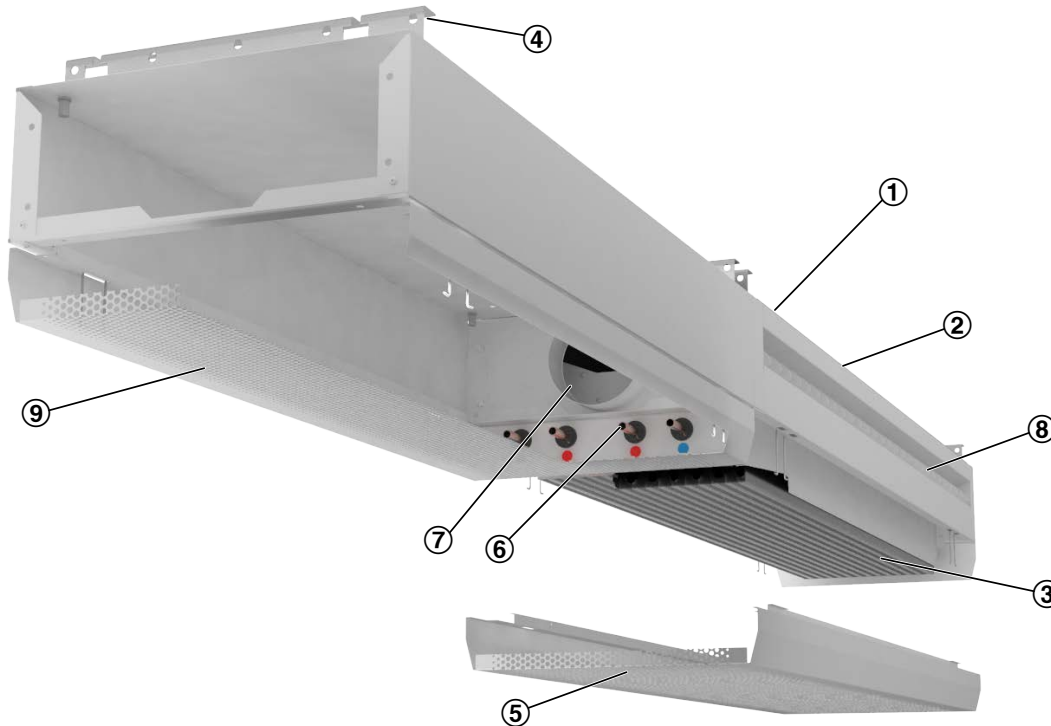

- ① DID-F
- ② Casing
- ③ Heat exchanger
- ④ Hanging bracket (optional)
- ⑤ Induced air grille

- ⑥ Water connection
- ⑦ Duct connection (primary air)
- ⑧ Air control blades (optional)
- ⑨ Duct covering (optional)

Principle of operation – DID-F

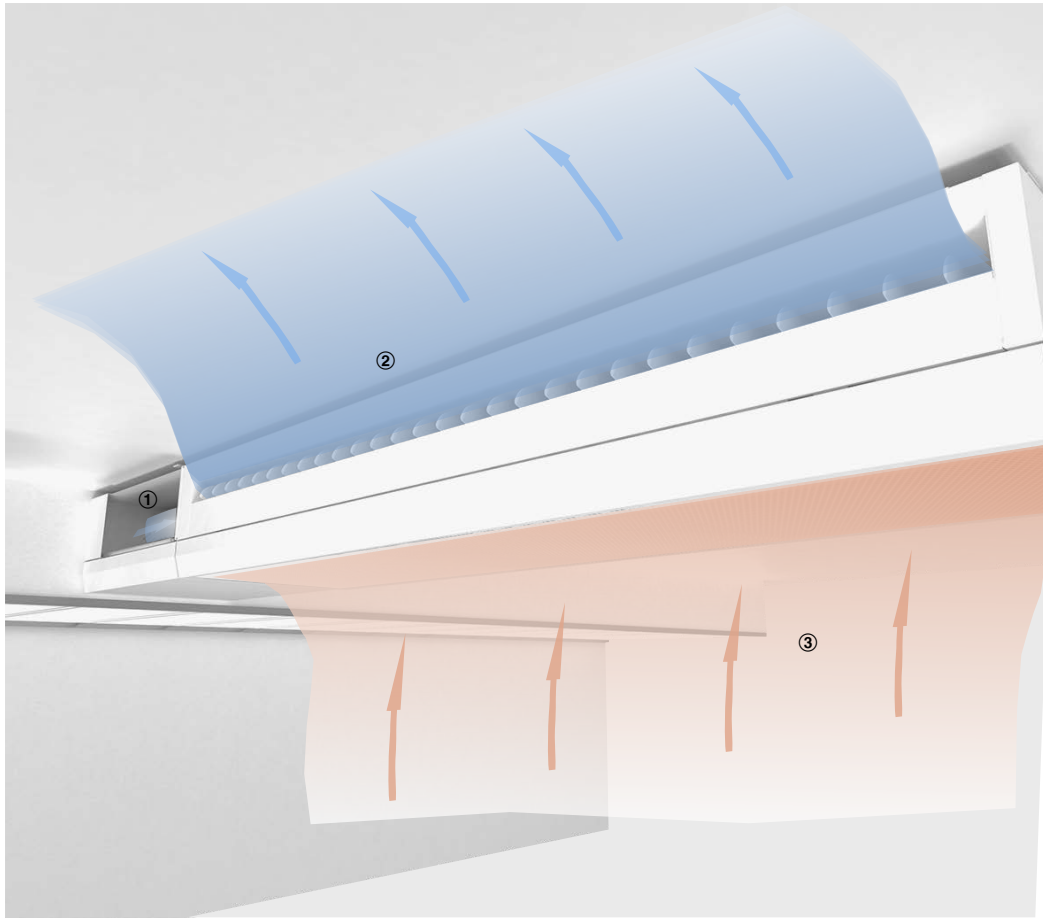

- ① Conditioned fresh air (primary air)
- ② Supply air

- ③ Room air (secondary air)

Technical data

Length = nominal length	1200, 1500, 1800, 2100, 2400, 2700 and 3000 mm
Height	221, 256, 296 mm
Width	400 mm
Diameter of entry spigot	123, 158 and 198 mm
Cooling capacity	Up to 4290 W
Heating capacity	Up to 2920 W
Max. operating pressure, water side	6 bar
Max. operating temperature	75 °C

Quick sizing

①	LN	Primary air			②	Cooling / 4-pipe system				Heating / 4-pipe system		
		qvPr [l/s]	qvPr [m ³ /h]	Δpt [Pa]		LWA [dB(A)]	Φ _{tot} [W]	Φ _{WK} [W]	t _{w,r} [°C]	ΔpW [kPa]	Φ _{tot} = Φ _{WH} [W]	t _{w,r} [°C]
HE	1200	13.33	48	63	< 15	795	634	17.8	12.6	992	44.3	1.1
HE	1200	26.39	95	248	33	1281	963	18.8	12.6	1305	42.5	1.1
HE	1500	16.67	60	64	< 15	976	775	18.2	15.4	1210	43.1	1.3
HE	1500	32.78	118	247	34	1555	1160	19.3	15.4	1575	41	1.3
HE	1800	20.28	73	67	< 15	1163	919	18.6	18.2	1425	41.8	1.6
HE	1800	39.17	141	249	34	1817	1345	19.9	18.2	1828	39.5	1.6
HE	2100	23.61	85	67	< 15	1290	1005	19.5	15.2	1622	40.7	1.8
HE	2100	45.56	164	248	35	1988	1439	21	15.2	2066	38.2	1.8
HE	2400	27.22	98	69	< 15	1456	1128	19.9	17.2	1818	39.6	2.1
HE	2400	51.94	187	250	35	2213	1587	21.5	17.2	2291	36.9	2.1
HE	2700	30.56	110	69	< 15	1605	1237	20.3	19.2	1997	38.6	2.3
HE	2700	58.06	209	249	35	2422	1722	21.9	19.2	2499	35.7	2.3
HE	3000	33.89	122	69	15	1749	1341	20.6	21.2	2168	37.6	2.6
HE	3000	64.44	232	249	35	2628	1852	22.4	21.2	2699	34.5	2.6
HE	1200	21.67	78	66	< 15	982	721	18.1	12.6	1087	43.8	1.1
HE	1200	41.94	151	249	36	1536	1030	19	12.6	1385	42.1	1.1
HE	1500	27.78	100	70	16	1228	893	18.6	15.4	1336	42.3	1.3
HE	1500	52.5	189	250	37	1875	1243	19.6	15.4	1673	40.4	1.3
HE	1800	33.33	120	70	16	1446	1045	19	18.2	1560	41.1	1.6



①	LN	Primary air			②	Cooling / 4-pipe system				Heating / 4-pipe system		
		qvPr [l/s]	qvPr [m³/h]	Δpt [Pa]		LWA [dB(A)]	Φtot [W]	ΦWK [W]	t _{w,r} [°C]	ΔpW [kPa]	Φtot = ΦWH [W]	t _{w,r} [°C]
HE	1800	62.78	226	249	37	2194	1438	20.1	18.2	1939	38.9	1.6
HE	2100	38.89	140	71	17	1605	1137	19.9	15.2	1773	39.8	1.8
HE	2100	73.06	263	250	38	2412	1532	21.3	15.2	2188	37.5	1.8
HE	2400	44.72	161	72	19	1807	1268	20.4	17.2	1980	38.4	2.1
HE	2400	83.06	299	250	39	2685	1684	21.8	17.2	2419	36.1	2.1
HE	2700	50.28	181	73	21	1994	1389	20.8	19.2	2172	37.5	2.3
HE	2700	92.78	334	249	40	2942	1824	22.3	19.2	2635	34.9	2.3
HE	3000	55.83	201	74	23	2175	1502	21.2	21.2	2354	36.5	2.6
HE	3000	102.5	369	249	41	3190	1955	22.7	21.2	2838	33.7	2.6
HE	1200	22.78	82	32	< 15	887	612	17.8	12.7	929	44.7	1.1
HE	1200	63.33	228	249	37	1865	1102	19.2	12.7	1398	42	1.1
HE	1500	28.89	104	33	< 15	1106	758	18.2	15.4	1143	43.4	1.3
HE	1500	79.17	285	247	< 38	2279	1325	19.8	15.4	1687	40.3	1.3
HE	1800	35	126	33	< 15	1319	897	18.6	18.2	1346	42.3	1.6
HE	1800	95.56	344	249	40	2686	1535	20.4	18.2	1960	38.8	1.6
HE	2100	40.83	147	34	< 15	1476	984	19.4	15.2	1535	41.2	1.8
HE	2100	111.39	401	250	41	2971	1629	21.6	15.2	2212	37.3	1.8
HE	2400	46.67	168	34	< 15	1660	1098	19.8	17.2	1716	40.2	2.1
HE	2400	127.22	458	250	42	3322	1789	22.2	17.2	2448	36	2.1
HE	2700	52.78	190	34	< 15	1847	1211	20.2	19.2	1894	39.1	2.3
HE	2700	142.5	513	250	43	3653	1936	22.7	19.2	2667	34.7	2.3
HE	3000	58.61	211	35	16	2021	1315	20.5	21.2	2059	38.2	2.6
HE	3000	157.5	567	250	45	3968	2071	23.1	21.2	2873	33.5	2.6
HE	1200	34.72	125	34	< 15	1119	700	18	12.6	1072	43.9	1.1
HE	1200	93.61	337	250	44	2278	1150	19.3	12.6	1520	41.3	1.1
HE	1500	43.89	158	35	17	1389	861	18.5	15.4	1311	42.5	1.3
HE	1500	117.5	423	250	45	2798	1382	20	15.4	1831	39.5	1.3
HE	1800	53.06	191	35	19	1652	1013	18.9	18.2	1537	41.2	1.6
HE	1800	141.11	508	250	47	3296	1596	20.6	18.2	2119	37.9	1.6
HE	2100	61.94	223	36	21	1850	1104	19.8	15.2	1747	40	1.8
HE	2100	163.61	589	250	48	3656	1685	21.8	15.2	2382	36.3	1.8
HE	2400	71.11	256	37	23	2089	1232	20.2	17.2	1951	38.8	2.1
HE	2400	183.06	659	243	50	4043	1838	22.3	17.2	2617	35	2.1
HE	2700	80	288	38	26	2314	1350	20.6	19.2	2141	37.7	2.3
HE	2700	188.61	679	209	50	4210	1937	22.7	19.2	2788	34	2.3
HE	3000	89.17	321	39	28	2539	1465	21	21.2	2325	36.7	2.6
HE	3000	189.17	681	174	50	4291	2012	22.9	21.2	2928	33.2	2.6

① Nozzle variant

② Sound power level

Reference values

Parameter	Cooling	Heating
tR	26 °C	22 °C
tPr	16 °C	22 °C
tWV	16 °C	50 °C
qv,W (LN 900 – 1800 mm)	300 l/h	150 l/h
qv,W (LN 2100 – 3000 mm)	250 l/h	150 l/h

Specification text

This specification text describes the general characteristics of the product. Texts for variants can be generated with our Easy Product Finder design program.

Active chilled beams of type DID-F with two-way air discharge are suitable for freely suspended or direct installation below the ceiling slab and offer optimum comfort thanks to the ideal discharge angle and maximum induction. The active chilled beam can be used on its own or as the perfect extension to concrete core activation since it has a positive impact on the thermal energy supplied to the room. This air-water system does not require a false ceiling, and the installation height should preferably not exceed 4 m. 3 different installation kits are optionally available for fixing, but the chilled beam can also be fixed without an installation kit, using standard fixing materials. This enables fast, straightforward installation, depending on the structural conditions. Sizing can be varied by choosing one of four possible nozzle sizes. The nozzles are punched into the nozzle plate and are non-combustible. The primary air flow rate can be low for hygiene and energy reasons. Together with the horizontal heat exchanger, this enables the dissipation of large heating and cooling loads. The water connections positioned on the narrow side are optionally available as plain tails, G½" external thread with flat seal or G½" union nut. The primary air connection is on the same connection side as the water connections and is available with a nominal diameter of 125 mm, 160 mm or 200 mm. This allows for direct connection of beam, e.g. from the corridor, avoiding complex duct and pipe layouts in the room. Circular ducts in accordance with EN 1506 or EN 13180 can be installed directly. Owing to the decreasing apertures of the induced air grille, the DID-F fits perfectly into its surroundings. The optional air control blades allow for air distribution to be adjusted manually at any time.

Special features

- The optional duct covering allows for installation of the active chilled beam in the middle of the ceiling even if a room is

large, as the same covering is used for ducts and water pipes to create a uniform look

- Manually adjustable air control blades for air direction control enable reduction of v_{h1} and v_l velocities in the occupied zone
- Horizontal heat exchanger as a 2-pipe system and, for direct installation below the ceiling and a maximum installation height of 4 m, also as a 4-pipe system for heating and cooling
- Internal nozzle plate with non-combustible punched nozzles
- Water connections at the narrow side, Ø12 mm Cu pipe with plain tails, with G½" external thread and flat seal, or with G½" union nut and flat seal

Materials and surfaces

- Casing, induced air grille, spigot, brackets and duct covering made of galvanised sheet steel
- Nozzle plate made of sheet steel
- Heat exchanger with copper tubes and aluminium fins
- Exposed surfaces are powder-coated pure white (RAL 9010) or in any other RAL CLASSIC colour
- Air control blades made of polypropylene, UL 94, flame retardant (V0)

Technical data

- Length = nominal length: 1200, 1500, 1800, 2100, 2400, 2700 and 3000 mm
- Height: 221, 256, 296 mm
- Width: 400 mm
- Diameter of spigot: 123, 158 and 198 mm
- Cooling capacity up to 4290 W
- Heating capacity up to 2920 W
- Max. operating pressure, water side: 6 bar
- Max. operating temperature: 75 °C

Order code

DID-F – 4 – S2 – A2 / 1200 x 123 x 1000 / A / LE / P1 – RAL ...
 | | | | | | | | | |
 1 2 3 4 5 6 7 8 9 10

1 Type

DID-F Active chilled beam

2 Heat exchanger

2 2-pipe

4 4-pipe

3 Nozzle variant

HE small

S1 medium

S2 large

HP extra large

4 Water connections

No entry: Ø12 mm pipe with plain tails

A1 with G½" external thread and flat seal

A2 with G½" union nut and flat seal

5 Nominal lengths [mm]

1200, 1500, 1800, 2100, 2400, 2700, 3000

6 Primary air spigot

123, 158, 198

7 Duct covering

No entry required: None

1000 Length 200 – 2900 mm

8 Fixing variant

No entry required: installation using the threaded blind holes M6

A Installation kit for installation directly under the ceiling slab

B Installation kit for freely suspended installation with brackets

C Installation kit for freely suspended installation with suspension brackets

9 Air control elements

No entry required: None

LE With air control blades

10 Exposed surface

No entry: powder-coated RAL 9010, pure white

P1 powder-coated, specify RAL CLASSIC colour

Order example: DID-F–2–S1/1500×123×

Heat exchanger	2-pipe system
Nozzle variant	Medium
Water connections	Ø12 mm pipe, plain tails
Length of unit	1500 mm
Primary air spigot, diameter	123 mm
Duct covering	None
Fixing variant	Threaded blind holes M6
Air control elements	None
Exposed surface	Powder-coated RAL 9010 GU 50, pure white

Order example: DID-F–4–S2–A2/1800×198×1000/A/LE/P1-RAL9016

Heat exchanger	4-pipe system
Nozzle variant	Large
Water connections	With G½" union nut and flat seal
Length of unit	1800 mm
Primary air spigot, diameter	198 mm
Duct covering	With duct covering 1000 mm long
Fixing variant	Installation kit for installation directly under the ceiling slab
Air control elements	With air control blades
Exposed surface	Powder-coated RAL 9016 GU 70, traffic white

Note: 4-pipe heat exchangers should only be used for installation directly below the ceiling slab and at an installation height of ≤ 4.0 m.

Variants

DID-F with duct connection



Application

- Duct covering provides a visually attractive covering for ducts and water pipes (by others) if the DID-F is installed in the middle of the ceiling
- Duct covering can be ordered in lengths from 200 – 2900 mm
- Duct covering is visually inconspicuous as its shape is similar to that of DID-F

Materials and surfaces

- Duct covering made of galvanised sheet steel
- Exposed surfaces are powder-coated pure white (RAL 9010) or in any other RAL CLASSIC colour

Water connections – Ø12 mm pipe, plain tails

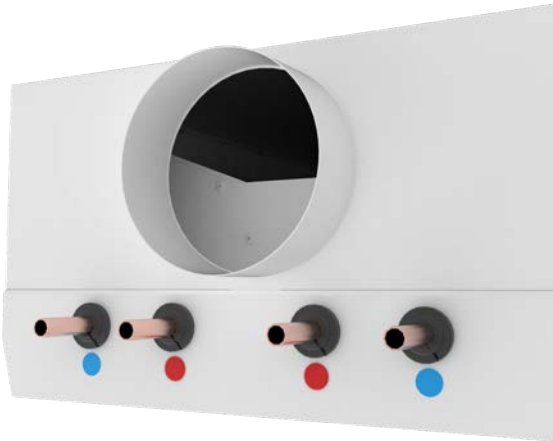
Water connections A1 – G $\frac{1}{2}$ " external thread and flat sealWater connections A2 – G $\frac{1}{2}$ " union nut and flat seal

Application

- Water connections form the interface between the active chilled beam and the pipe network in the building
- Three types of pipe connections are available to suit individual requirements
- Ø12 mm copper with plain tails – particularly suitable for direct connection to a copper pipe network; all the usual connection methods can be used, such as soldering, press-fit and push-fit
- A1, G $\frac{1}{2}$ " external thread and flat seal – particularly suitable for a detachable connection with union nuts
- A2, G $\frac{1}{2}$ " union nut and flat seal – this is also a detachable solution and is particularly suitable for direct connection of control valves and shut-off valves
- All connections provided by others must be tested under pressure once installed to ensure that there are no leaks

Nominal sizes

- 1200, 1500, 1800, 2100, 2400, 2700, 3000 mm

Useful additions

- Type FS connecting hoses are available for all water connection variants

Suspension with blind holes, front

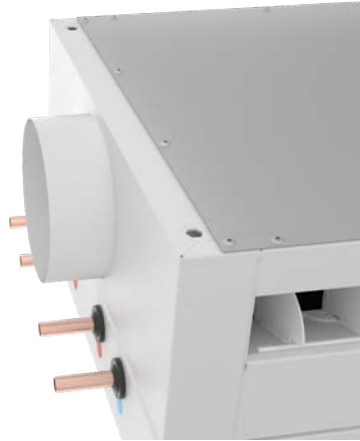

Suspension with blind holes, rear



Suspension variant A – insertion, front



Suspension variant A – insertion, rear



Suspension variant B – brackets, front



Suspension variant B – brackets, rear



Suspension variant C – suspension lugs, front

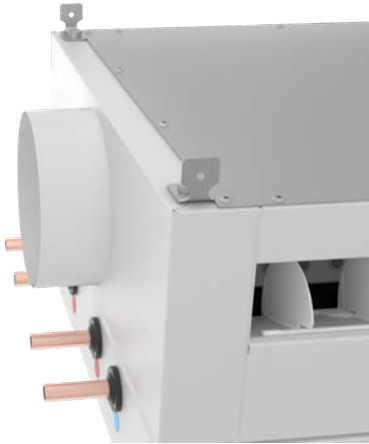

Suspension variant C – suspension lugs, rear



Application

- Type DID-F active chilled beams are suitable for direct installation below the ceiling slab or freely suspended in the room
- A suspended ceiling is not required, which means that these devices can ideally be combined with concrete core activation
- Preferably for installation up to 4 m high, even if the room is higher
- Heating with the DID-F is only possible if the device is installed directly below the ceiling slab and the installation height is ≤ 4 m
- Adjustable air control blades allow for later manual adjustment of the air discharge direction
- Preferably with a 2-pipe heat exchanger for cooling; with direct installation below the ceiling slab, a 4-pipe heat exchanger for cooling and heating is an option
- Good comfort levels with a low conditioned primary air volume flow rate
- Energy-efficient solution as water is used for heating and cooling

Dimensions

DID-F

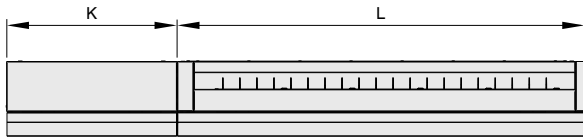

DID-F

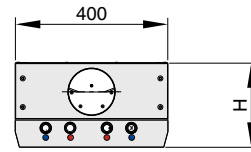

DID-F air and water connections

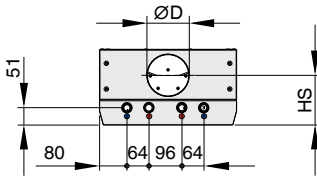

Suspension variant A – insertion

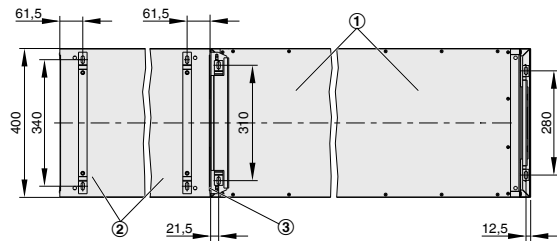

- ① DID-F
- ② Duct covering
- ③ Abutting edges of DID-F and duct covering

Suspension variant B – brackets

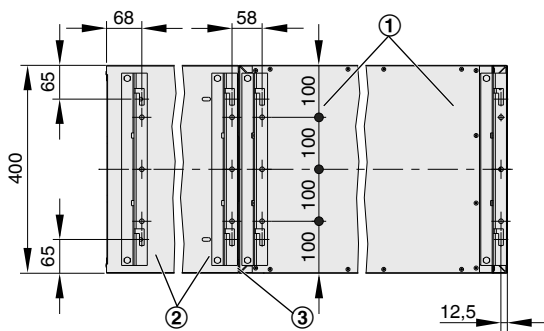

Suspension variant C – suspension lugs

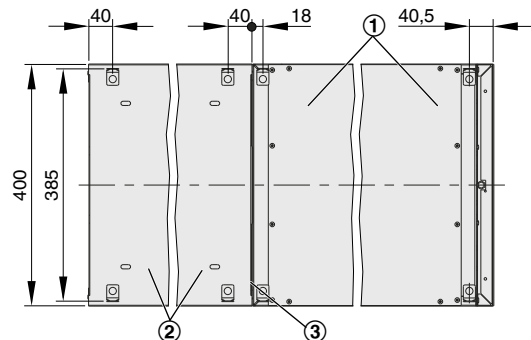

- ① DID-F
- ② Duct covering
- ③ Abutting edges of DID-F and duct covering

- ① DID-F
- ② Duct covering
- ③ Abutting edges of DID-F and duct covering

ØD	H	HS
123	221	147
158	256	164.5
198	296	184.5

K	200 – 2900 in mm increments
L	1200, 1500, 1800, 2100, 2400, 2700, 3000 mm

Dimensions – 1 side entry spigot

LN		①	②	③
1200	HE	158	123 & 198	
1500	HE	158	123 & 198	
1800	HE	158	123 & 198	
2100	HE	158	123 & 198	
2400	HE	158	123 & 198	
2700	HE	158	123 & 198	
3000	HE	158	123 & 198	
1200	S1	158	123 & 198	
1500	S1	158	123 & 198	
1800	S1	158	123 & 198	
2100	S1	158	123 & 198	
2400	S1	158	123 & 198	
2700	S1	158	123 & 198	
3000	S1	158	123 & 198	
1200	S2	198	158	
1500	S2	198	158	
1800	S2	198	158	
2100	S2	198	158	
2400	S2	198	158	
2700	S2	198	158	
3000	S2	198	158	
1200	HP	198	158	
1500	HP	198	158	
1800	HP	198	158	
2100	HP	198	158	
2400	HP	198	158	

LN	①	②	③
2700	HP	198	158
3000	HP	198	158

① Nozzle type ② Standard diameter of the spigot ③ Optional diameter of spigot

DID-F water connections

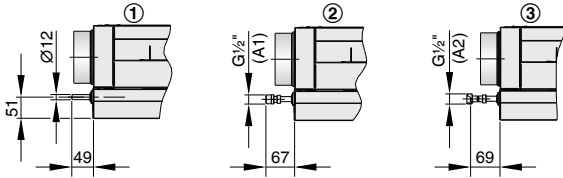

- ① Water connection, $\varnothing 12$
- ② Water connection A1 (G $\frac{1}{2}$ " external thread)
- ③ Water connection A2 (G $\frac{1}{2}$ " union nut)

DID-F fixing variant

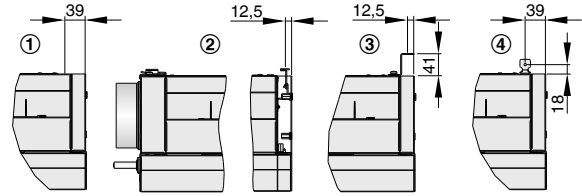

- ① Freely suspended installation with threaded rods
- ② Suspension variant A (installation directly below the ceiling slab)
- ③ Suspension variant B (freely suspended installation with brackets)
- ④ Suspension variant C (freely suspended installation with suspension lugs)

Project-specific solutions

DID-F-L with luminaires



DID-F-L luminaire detail



DID-F-L with luminaires and extended border



DID-F top entry spigot



Air-water systems offer both standard and project-specific solutions; they can be combined with luminaires or can have a top entry spigot. If required, we can also develop a suitable project-specific variant for your project. Simply contact your TROX contact partner.



Nomenclature

L_{WA} [dB(A)]

Sound power level

Φ_{tot} [W]

Thermal output – total

q_v [l/h]

Volume flow rate

q_{vPr} [m³/h]; [l/s]

Primary air volume flow rate

q_{vW} [l/h]

Water flow rate – cooling/heating

$\Phi_{W,K}$ [W]

Thermal output – water side, cooling

$\Phi_{W,H}$ [W]

Thermal output – water side, heating

t_{Pr} [°C]

Primary air temperature

t_R [°C]

Room temperature

t_{WV} [°C]

Water flow temperature – cooling/heating

Δp_t [Pa]

Total pressure drop, air side

Δp_W [kPa]

Pressure drop, water side

$\Delta t_{Pr} = t_{Pr} - t_R$ [K]

Difference between primary air temperature and room temperature

Δt_W [K]

Temperature difference – water

Δt_{Wm-Ref} [K]

Difference between mean water temperature and reference temperature

LN [mm]

Nominal length